

Hardware

Manufactured with durable, long-lasting polyurethane, these polyslide rollers will not mar boat surfaces. They are superior to rubber rollers in cut and tear-resistance.

POLYSLIDE KEEL ROLLERS

Part #	Length	Hole ID
PR4-5	4"	1/2"
PR5-5	5"	1/2"
PR8	8"	5/8"
PR10	10"	5/8"
PR12	12"	5/8"

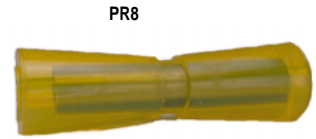

POLYSLIDE BOW STOP ROLLERS

Part #	Length	Hole ID
PR3B	3"	1/2"
PR4B	4"	1/2"

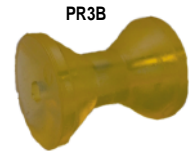

POLYSLIDE END CAP ROLLER

Part #	Length	Hole ID
PR325	3/4"	5/8"



POLYSLIDE BOW STOPS

Part #	Description	Length	Hole ID
PR3V	V bow stop	3"	1/2"
PR4V	V bow stop	4"	1/2"
PA3	Jet ski bow stop	n/a	5/8"
PA4	Jet ski/waverunner bow stop	n/a	5/8"
PA5	Super jet/waverunner III bow stop	n/a	5/8"

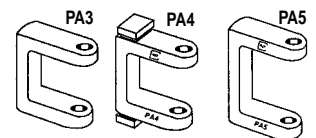
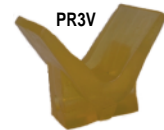

Our molded "Y" bow stops are made of non-marking black rubber and have non-sleeved inner diameter holes.

BLACK RUBBER MOLDED "Y" BOW STOPS

Part #	Base	Span	Hole ID
4Y22-3	2" x 2"	4"	3/8"
6Y33-4	3" x 3"	6"	1/2"
7Y44-4	4" x 4"	7"	1/2"



These end caps are made of non-marking black rubber and have non-sleeved inner diameter holes.

BLACK RUBBER END CAPS

Part #	Application	Diameter	Height	Hole ID
224-5	For side guide rollers	2 1/2"	2"	5/8"
130-4	For bow, spool and keel rollers	3"	1 1/4"	1/2"
134-4	For bow, spool and keel rollers	3 1/2"	1 1/4"	1/2"
134-5	Black rubber, plain inner diameter, non-marking	3 1/2"	1 1/4"	5/8"
220-4	Black rubber, plain inner diameter, non-marking	2"	2"	1/2"
224-4	Black rubber, plain inner diameter, non-marking	2 1/2"	2"	1/2"



Hardware

These rollers are made of non-marking black rubber. The keel rollers have a steel sleeve and nylon end caps. The spool rollers have a plastic sleeve. The wobble roller has a chemically bonded, zinc-chromated washer.

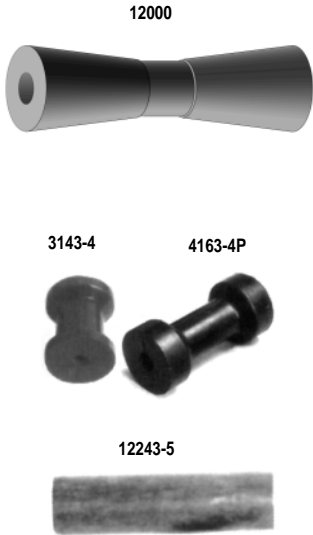

BLACK RUBBER ROLLERS			
Part #	Description	Length	Hole ID
3143-4	Bow roller	3"	1/2"
4174-4	Bow roller	4"	1/2"
4163-4P	Spool roller	4"	1/2"
4163-5	Spool roller	4"	5/8"
5203-4P	Spool roller	5"	1/2"
5203-5P	Spool roller	5"	5/8"
5000	Keel roller	5"	5/8"
8000	Keel roller	8"	5/8"
10000	Keel roller	10"	5/8"
12000	Keel roller	12"	5/8"
18244-165EC	Keel roller	18"	5/8"
343-R-6P	Wobble roller	4.375"	7/8"
440-R	Wobble roller	4.5"	7/8"
12243-5	Side/guide roller	12"	5/8"

These one piece keel roller brackets have a 5" slot for vertical adjustment. They mount with a 1/2" bolt, use a 5/8" roller shaft and are made of 11 gauge steel.



ROLLER BRACKETS			
Part #	Material	Roller Size	Slot Center
RB411Z	Zinc	4"	2 1/2"
RB511Z	Zinc	5"	2 3/4"
RB811Z	Zinc	8"	5 3/4"
RB1011Z	Zinc	10"	8 5/8"
RB1211Z	Zinc	12"	10 1/8"
RB411G	Galvanized	4"	2 1/2"
RB511G	Galvanized	5"	2 3/4"
RB811G	Galvanized	8"	5 3/4"
RB1011G	Galvanized	10"	8 5/8"
RB1211G	Galvanized	12"	10 1/8"

Split roller brackets mount with a 1/2" bolt, utilize a 5/8" roller shaft and are made of 9 gauge steel.

SPLIT ROLLER BRACKET	
Part #	Description
SRB911Z	Split roller bracket, both sides, zinc

Hardware

A long single slot allows maximum vertical adjustment of the bolster brackets. The angle brackets have a mounting bolt size of 7/16".

BUNK AND BOLSTER BRACKETS

Part #	Description	Material	Length
BB811Z	Bolster bracket	Zinc	8"
BB1011Z	Bolster bracket	Zinc	10"
BB1211Z	Bolster bracket	Zinc	12"
BB811G	Bolster bracket	Galvanized	8"
BB1011G	Bolster bracket	Galvanized	10"
BB1211G	Bolster bracket	Galvanized	12"
FCB1011Z	Bunk bracket	Zinc	10"
FCB1211Z	Bunk bracket	Zinc	12"
FCB1011G	Bunk bracket	Galvanized	10"
FCB1211G	Bunk bracket	Galvanized	12"
AB11Z	Angle bracket	Zinc	3.5"
AB11G	Angle bracket	Galvanized	3.5"

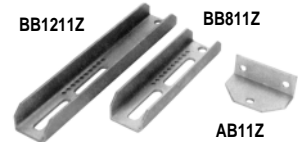

Our roller shafts are zinc plated and cut to accept pal nuts.

ROLLER SHAFTS

Part #	Description	Size
RS12525Z	Zinc 1/2" roller shaft	5 1/4" x 1/2"
RS12625Z	Zinc 1/2" roller shaft	6 1/4" x 1/2"
RS58525Z	Zinc roller shaft	5 1/4" x 5/8"
RS58575Z	Zinc roller shaft	5 3/4" x 5/8"
RS58625Z	Zinc roller shaft	6 1/4" x 5/8"
RS58825Z	Zinc roller shaft	8 1/4" x 5/8"
RS58925Z	Zinc roller shaft	9 1/4" x 5/8"
RS5811125Z	Zinc roller shaft	11 1/4" x 5/8"
RS5812Z	Zinc roller shaft	12" x 5/8"
RS581325Z	Zinc roller shaft	13 1/4" x 5/8"
RS5813875Z	Zinc roller shaft	13 3/8" x 5/8"
RS5816Z	Zinc roller shaft	16" x 5/8"
RS5819Z	Zinc roller shaft	19" x 5/8"

RS58525Z



PAL NUTS

Part #	Description	Size
8402	Pal nut, zinc	1/2"
8401	Pal nut, zinc	5/8"

8401

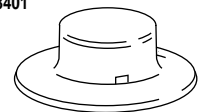

WWW.QTRAILER.COM

Hardware

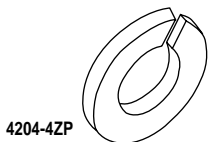
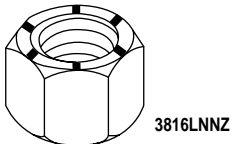
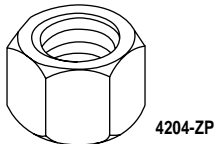
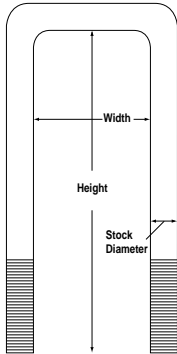
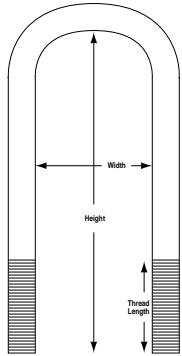
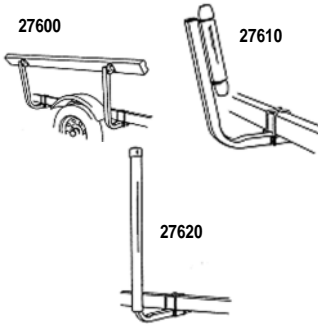

GUIDE ON ASSEMBLIES

Part #	Description
27600	Bunk (board type) guide on, boxed pair
27610	Roller guide on galvanized, boxed pair
27620	Post guide on, boxed pair

U BOLTS, 3/8" - 16

Part #	Finish	Style	Width	Height	Thread Length
4209-1SS	Stainless steel	Square	3"	4"	1 3/4"
4213-1SS	Stainless steel	Round	1 1/4"	2 1/16"	1 1/2"
4238-1SS	Stainless steel	Square	2 5/8"	4 1/8"	2"
4235-1SS	Stainless steel	Square	3 3/16"	4 3/4"	2"
4255-1ZP	Zinc plated	Round	1 5/8"	2 1/4"	1"
4206-1ZP	Zinc plated	Square	1 3/4"	4 3/8"	2"
4214-1ZP	Zinc plated	Square	2 1/16"	2 1/2"	1 3/4"
4215-1ZP	Zinc plated	Square	2 1/16"	3 1/2"	2"
4216-1ZP	Zinc plated	Square	2 1/16"	4"	2"
4260-1ZP	Zinc plated	Square	2 1/16"	5 1/4"	2"
4209-1ZP	Zinc plated	Square	3"	4"	1 3/4"

U BOLTS, 7/16" - 14

Part #	Finish	Style	Width	Height	Thread Length
4217-1ZP	Zinc plated	Square	2 1/16"	2 1/4"	1 3/8"
4218-1ZP	Zinc plated	Square	2 5/8"	3"	2"
4219-1ZP	Zinc plated	Square	2 5/8"	3 1/2"	2"
4220-1ZP	Zinc plated	Square	3 1/8"	3"	2"
4221-1ZP	Zinc plated	Square	3 1/8"	4"	2"
4222-1ZP	Zinc plated	Square	4 1/8"	2 3/4"	2"

NUTS - ZINC PLATED

Part #	Description
4204-2ZP	3/8" - 16
716-14LNZ	7/16" - 14
4201-2ZP	1/2" - 13

LOCK NUTS WITH NYLON INSERT

Part #	Description
3816LNNZ	Zinc, 3/8" - 16
71614LNNZ	Zinc, 7/16" - 14
1213LNNZ	Zinc, 1/2" - 13
3816LNNZ	Stainless, 3/8" - 16
1213LNNZ	Stainless, 1/2" - 13

WASHERS- ZINC PLATED

Part #	Description
4204-4ZP	3/8"
716LWZ	7/16"
4201-4ZP	1/2"

Note: 1/2" U-Bolts on following page

WWW.QTRAILER.COM

QUALITY
TRAILER PRODUCTS, INC.
— POLAR — company

POLAR
SERVICE CENTERS

Century WHEEL & RIM
a division of Quality Trailer Products

Hardware

U BOLTS, 1/2" - 13

Part #	Finish	Style	Width	Height	Thread Length
4210-1SS	Stainless steel	Round	2"	4 1/4"	2"
4211-1SS	Stainless steel	Round	2"	5 1/4"	2"
4226-1SS	Stainless steel	Square	1 5/8"	4"	2"
4244-1SS	Stainless steel	Square	2 1/6"	3 3/4"	1 3/8"
4243-1SS	Stainless steel	Square	2 1/6"	4 3/4"	2"
4242-1SS	Stainless steel	Square	2 1/6"	6 1/4"	2 1/2"
4212-1SS	Stainless steel	Square	3"	4 1/4"	2"
4251-1SS	Stainless steel	Square	3 1/6"	4 5/8"	2"
4224-1SS	Stainless steel	Square	3 1/6"	5 1/4"	2"
4241-1SS	Stainless steel	Square	3 1/6"	6 1/4"	2"
4240-1SS	Stainless steel	Square	3 1/6"	7 1/4"	2 1/2"
4225-1SS	Stainless steel	Square	4 1/8"	4 1/4"	2"
4203-1LZP	Zinc plated	Round	2"	6 1/2"	2"
4203-12ZP	Zinc plated	Round	2 1/2"	5 1/4"	1 3/4"
4212-1ZP	Zinc plated	Round	3"	4"	2"
4226-1ZP	Zinc plated	Square	1 5/8"	4"	2"
4210-1ZP	Zinc plated	Square	2"	4 1/4"	2"
4211-1ZP	Zinc plated	Square	2"	5 1/4"	2"
4203-1ZP	Zinc plated	Square	2"	5 1/2"	3"
4252-1ZP	Zinc plated	Square	2 1/6"	4 1 3/8"	2"
4202-1ZP	Zinc plated	Square	2 3/8"	5 1/2"	1 3/4"
4224-1ZP	Zinc plated	Square	3"	5 1/2"	2"
4233-1ZP	Zinc plated	Square	3 1/6"	3 1 3/8"	2"
4225-1ZP	Zinc plated	Square	4 1/8"	4 1/4"	2"

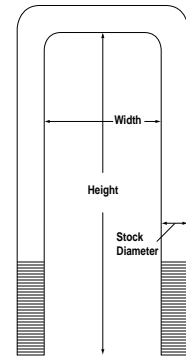
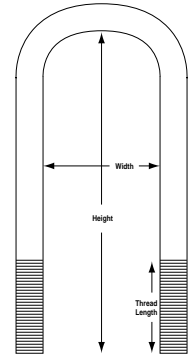

The Strong Arm electric winches from Dutton-Lainson use heat-treated sintered-iron gears for smooth, quiet operation.

ELECTRIC WINCHES

Part #	Volts	Rated Load Capacity	Gear Ratio	Cable Size and Length	Pulley Block and Hook
SA5000	12 volt DC	1,500 lbs.	194:1	3/16" x 20'	
SA7000	12 volt DC	2,200 lbs.	194:1	3/16" x 50'	●
SA9000	12 volt DC	3,000 lbs.	584:1	7/32" x 25'	●
SA12000	12 volt DC	4,500 lbs.	584:1	7/32" x 50'	●
SA5000-AC	120 volt AC	1,200 lbs.	194:1	3/16" x 20'	
SA7000-AC	120 volt AC	1,800 lbs.	194:1	3/16" x 50'	●
SA9000-AC	120 volt AC	2,700 lbs.	584:1	7/32" x 25'	●
SA12000-AC	120 volt AC	4,000 lbs.	584:1	7/32" x 50'	●

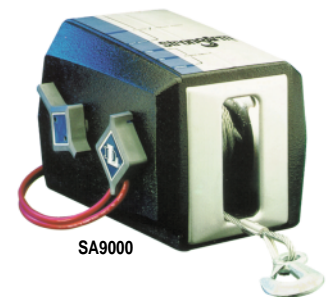

Hardware

Dutton-Lainson's marine winches are ideal for both marine and industrial use. They are available in a variety of sizes and capacities. They come with a three-year warranty and are available zinc-plated. Results of lab tests using 5% neutral salt spray confirm the new TUFFPLATE™ finish provides 500+ hours against first red rust and in excess of 100 hours for first white corrosion.



3606-DL

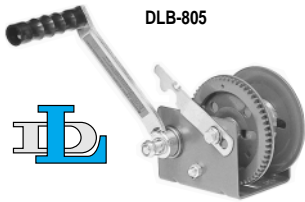

DLB-805



MARINE WINCHES – DUTTON-LAINSON

Part #	Capacity	Ratchet Style	Gear Ratio
3606-DL	600 lbs.	1-way	3.2:1
3608-DL	900 lbs.	1-way	3.2:1
3610-DL	1,100 lbs.	1-way	3.9:1
3613-DL	1,300 lbs.	1-way	4.5:1
3614-DL	1,400 lbs.	2-way	4.5:1
3616-DL	1,600 lbs.	2-way	5.5:1
3618-DL	1,800 lbs.	2-way	5.5:1
3620-DL	2,000 lbs.	2-way	12.5:1 & 5.5:1
3626-DL	2,500 lbs.	2-way	17:1 & 5.5:1
3630-DL	3,000 lbs.	2-way	17:1 & 5.5:1

DUTTON-LAINSON BRAKE WINCHES

Part #	Capacity	Gear Ratio	Features
DLB-805	800 lbs.	4.5:1	Freewheel
DLB-1205	1200 lbs.	5.5:1	Freewheel

Fulton's boat/trailer winches have a plated body and drum for rust resistance and longer life. Heavy-duty 2-speed winches for easier loading of larger boats are available. They also have a frame-strengthening cross shaft and ratchet bolts to resist damage to the ratchet. Free-wheeling and neutral positions play out the line without spinning the handle resulting in safer operation.

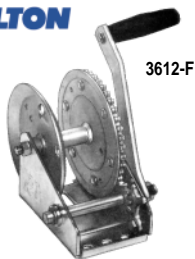

3612-F

5402



5407

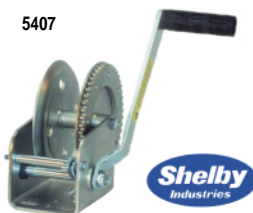

MARINE WINCHES – FULTON

Part #	Capacity	Ratchet Style	Gear Ratio
3606-F	600 lbs.	1-way	3.1:1
3609-F	900 lbs.	1-way	3.1:1
3610-F	1,100 lbs.	2-way	4.1:1
3612-F	1,300 lbs.	2-way	4.1:1
3614-F	1,500 lbs.	2-way	5.1:1
3616-F	1,600 lbs.	2-way	5.1:1
3618-F	1,800 lbs.	2-way	5.1:1
3626-F	2,600 lbs.	2-way	5.1:1 & 12.2:1
3637-F	3,700 lbs.	2-way	5.1:1 & 15.8:1

Posi-Lock hand winches are for marine, recreational and utility uses. They are made of rugged high-carbon steel and feature cold-forged steel one-piece pinion gear and shaft.

SHELBY SINGLE SPEED WINCHES

Part #	Capacity	Ratchet Style	Gear Ratio
5402	600 lbs.	1-way	3.1:1
5403	900 lbs.	1-way	3.1:1
5404	1,200 lbs.	1-way	4.1:1
5405	1,400 lbs.	2-way	4.1:1
5407	1,700 lbs.	2-way	5.1:1
5408	1,900 lbs.	2-way	5.1:1
5409	2,100 lbs.	2-way	5.1:1

Hardware

Posi-lock two-speed hand winches are ideal for marine, industrial, construction or agricultural use. You can change speed (gear ratios) without removing the handle. Simply press the locking level and shift handle from side-to-side to change gears or free spool. Features include:

- Zinc-plating,
- Higher load capacities,
- Better gear ratios for easier cranking of heavy loads,
- All gears are heat-treated to provide longer life,
- All winches have a 2-way ratchet which free spools in the “center” position,

SHELBY TWO-SPEED WINCHES			
Part #	Capacity	Ratchet Style	Gear Ratio
5462	2,300 lbs.	2-way	4.1:1 & 11.1:1
5470	2,800 lbs.	2-way	5.1:1 & 14.7:1
5480	3,200 lbs.	2-way	5.1:1 & 14.7:1

These winches are specifically designed and adapted to meet the rigorous demands of the agriculture market. They feature a large 2" hub for steel cable applications. These winches are to be used with a steel cable.

SHELBY AGRICULTURAL/INDUSTRIAL WINCHES			
Part #	Capacity	Ratchet Style	Gear Ratio
5414	1,200 lbs.	1-way	4.1:1
5417	1,700 lbs.	2-way	5.1:1

RATCHET WINCHES	
Part #	Description
DL400	400 lb. capacity
5400	400 lb. capacity, zinc plated

ELECTRIC WINCH ACCESSORIES	
Part #	Description
6371-DL	12 volt remote switch for StrongArm winches
6372-DL	120 volt remote switch for StrongArm winches
6363-DL	Vinyl winch cover

WINCH HANDLES			
Part #	Manufacturer	Application	Handle Length
0854-11	Shelby	Fits 5407 and 5408	8"
2400-11	Shelby	Fits 5470 and 5480	10"
2702-H	Shelby	Fits 5409	10"
3612-H	Fulton	Fits 3612-F	8"
3637-H	Fulton	Fits 3637-F	10"
6307-DL	Dutton-Lainson	Fits 3606-DL, 3608-DL, 3610-DL, 3613-DL	7"
6318-DL	Dutton-Lainson	Fits 3614-DL	9½"
6319-DL	Dutton-Lainson	Fits 3616-DL	9½"
6322-DL	Dutton-Lainson	Fits 3618-DL, 3620-DL and 3626-DL	9½"



Hardware



6213

WINCH CABLES/HOOK			
Part #	Length	Diameter	Capacity
3656	20'	1/8"	2,000 lbs.
3651	20'	3/16"	4,200 lbs.
3653	25'	3/16"	4,200 lbs.
3657	50'	3/16"	4,200 lbs.
6213	25'	7/32"	5,600 lbs.
6212	50'	7/32"	5,600 lbs.
3655	25'	1/4"	7,000 lbs.

These winch straps fit most models and styles of winches and come complete with a snap hook on one end. The 3650-2 has a loop on the snap hook end for use with personal watercraft.



3650

BOAT WINCH STRAPS		
Part #	Size	Description
6147	2" x 12'	Loop end
3650-2	2" x 12'	Loop end, loop over snap hook
3650	2" x 20'	Loop end
3650-1	2" x 35'	Loop end

Secure a vehicle that is being towed with a wheel tiedown. They safely prohibit movement and reduce wheel damage.

7421



7422

WHEEL TIEDOWNS	
Part #	Description
7421	Non-adjustable, pair with 801-W ratchets
7421-LR	Non-adjustable, pair less ratchets
7422	Adjustable, pair with 801-W ratchets
7422-LR	Adjustable, pair less ratchets
801-W	Ratchet, for 2" wheel net, with 6" strap and flat hook

Tie-down straps can be used in many different ways and in many different applications to secure cargo on trucks and trailers. The 1" straps are available in 2 lengths and with 2 securing mechanisms.



30R15S

TIE-DOWN STRAPS		
Part #	Size	Description
20B5S	1" x 5' strap	"S" hooks on both ends, with cam buckle
30R15S	1" x 15' strap	"S" hooks on both ends, with ratchet



7420



These straps are made of a polyester web which is treated for weather protection. 7420-1 includes a wide handle, heavy duty ratchet and the short end of the strap.

RATCHET AND RATCHET STRAPS			
Part #	Description	Breaking Strength	Working Load Limit
7420	Strap and ratchet, 2" x 27'	10,000 lbs.	3,000 lbs.
7420-1	Ratchet only	10,000 lbs.	3,000 lbs.

Hardware

Our winch straps are made of a heavy-duty polyester web for long-lasting protection against the weather. Straps have a standard flat hook on one end.

WINCH STRAPS

Part #	Size	Breaking Strength	Working Load Limit
7420-SO	2" x 27' strap	10,000 lbs.	3,000 lbs.
7420-WS	4" x 30' strap	20,000 lbs.	5,000 lbs.



These strap winches are used to secure all types of cargo. They are available in three models: a fixed winch designed to be welded in place, a portable winch, and a storable winch designed to mount on a side channel to store entire strap. They accept up to 4" webbing.

STRAP WINCHES

Part #	Description	Application	Storage Capacity
7429	Weld-on winch, low profile	Side mount	Stores 10' of 4" webbing
7429-P	Weld-on winch, low profile, portable	Side mount	Stores 10' of 4" webbing
7429-S	Weld-on winch, storable	Bottom mount	Stores 30' of 4" webbing
6655	Bolt-on winch, storable	Bottom or side mount	Stores 5' of 2" webbing

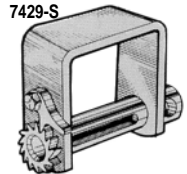
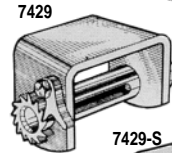
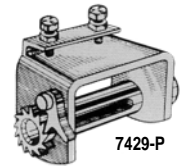

Our heavy-duty rubber straps come with metal S-hooks on both ends.

TARP STRAPS AND HOOKS

Part #	Description
TS15	15" rubber length
TS21	21" rubber length
TS31	31" rubber length
TS41	41" rubber length
B2447BP	¾" long tarp hook with mounting holes
B2447NHP	¾" long tarp hook, weld on



Our general purpose chain can be used as a tow chain or tie-down chain. It does not have the rated load strength of a high-test chain and should not be used for direct overhead lifting.

GENERAL PURPOSE CHAIN

Part #	Size of Link	Work Load Rating	Sold By	Number of Feet
GP316	⅜"	750 lbs.	Foot	1
GP316-P	⅜"	750 lbs.	Pail	250
GP316-D	⅜"	750 lbs.	Drum	800
GP14	¼"	1,250 lbs.	Foot	1
GP14-P	¼"	1,250 lbs.	Pail	141
GP14-D	¼"	1,250 lbs.	Drum	800
GP516	⅝"	1,900 lbs.	Foot	1
GP516-P	⅝"	1,900 lbs.	Pail	92
GP516-D	⅝"	1,900 lbs.	Drum	550
GP38	⅜"	2,650 lbs.	Foot	1
GP38-P	⅜"	2,650 lbs.	Pail	63
GP38-D	⅜"	2,650 lbs.	Drum	400



Campbell®

Hardware

These high-test chains are used for towing, binding, or logging.

HT14



HIGH-TEST CHAIN				
Part #	Size of Link	Work Load Rating	Sold By	Number of Feet
HT14	1/4"	2,600 lbs.	Foot	1
HT14-P	1/4"	2,600 lbs.	Pail	150
HT14-D	1/4"	2,600 lbs.	Drum	400
HT516	5/16"	3,900 lbs.	Foot	1
HT516-P	5/16"	3,900 lbs.	Pail	100
HT516-D	5/16"	3,900 lbs.	Drum	550
HT38	3/8"	5,400 lbs.	Foot	1
HT38-P	3/8"	5,400 lbs.	Pail	75
HT38-D	3/8"	5,400 lbs.	Drum	400

SC31648



SAFETY CHAIN			
Part #	Chain Size	Capacity	Number of Hooks
SC31618	3/16" x 18"	3,200	1
SC31626G	3/16" x 26" Galvanized	3,200	1
SC31648	3/16" x 48"	3,200	2
SC1424	1/4" x 24"	5,200	1
SC1442	1/4" x 42"	5,200	2
SC1448	1/4" x 48"	5,200	2
SC1454	1/4" x 54"	5,200	2
SC51630G	5/16" x 30" Galvanized	5,200	1
SC113254	1 1/2" x 54"	7,600	2
SC3835	3/8" x 35"	7,600	1

Warning: SAE Code states that two lengths of safety chain or equivalent must be used. They must be connected from opposite sides of the trailer tongue to the towing vehicle and when passing forward to the towing vehicle must be crossed under the trailer tongue in such a manner that they will cradle the trailer coupling tongue in the event of separation of the coupling or ball.

We offer a black jacketed, class III steel safety cable. It has an S-hook on one end and a bolt loop on the other for attachment. Two safety cables meet SAE regulations.

SAFETY CABLE	
Part #	Description
SCB1436	1/2" safety cable, 36" long, 7/16" diameter S-hook on one end, pair

GNSC3835



These gooseneck safety chains are designed to meet regulations for gooseneck trailers.

GOOSENECK SAFETY CHAIN			
Part #	Chain Size	Capacity	Description
GNSC3835	3/8"	15,000	Gooseneck safety chain, with hook
GNSC3835NH	3/8"	15,000	Gooseneck safety chain, with out hook
GNSC3837	3/8"*	25,000	Gooseneck safety chain, with clevis hook, tagged
GNSC71637	7/16"*	30,000	Gooseneck safety chain, with clevis hook, tagged

* High Test

320105



CHAIN BINDER	
Part #	Description
320105	Chain binder with 3/8" grab hooks

Hardware

Use these chain connectors to replace broken chain links. All are zinc plated.

CHAIN CONNECTORS

Part #	Size	Working Load Limit
CC-316	3/16" diameter x 1" length	240 lbs.
CC-14	1/4" diameter x 1 1/2" length	400 lbs.
CC-516	5/16" diameter x 1 1/2" length	950 lbs.
CC-38	3/8" diameter x 1 5/8" length	1,250 lbs.

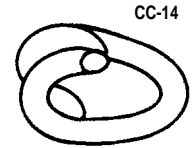

CC-14

Our heat-treated safety chain hooks are made of high-test steel for strength and dependability.

SAFETY CHAIN HOOKS

Part #	Description
7446	3/8" diameter, for 3/16" chain (class I and II hitches)
7445	7/16" diameter, for 1/4" chain (class III hitches)
7447	1/2" diameter, for 1/2" chain (class IV hitches)



7446

SLIP HOOKS

Part #	Description
M905ZL	Clevis slip hook, 5/16"
M906ZL	Clevis slip hook, 3/8"



M905ZL



M906ZL

GRAB HOOKS

Part #	Description
M805ZL	Clevis grab hook, 5/16"
M806ZL	Clevis grab hook, 3/8"

All of our snap hooks are designed for quick connecting and disconnecting of cables, ropes and chains.

SNAP HOOKS

Part #	Description
SN-161	Snap hook, double-ended, 3 1/2"
SN-162	Snap hook, double-ended, 4"
SN-38	Snap hook, 3/8" eye
SN-58	Snap hook, 5/8" eye
SN-225X	Snap hook, 5/8" eye, swivel



SN-161

SN-38

SN-225X

Our lynch pins and hitch pins are yellow zinc plated for corrosion protection. Hitch pins include hair pin.

LINCH PINS

Part #	Size
66000	1/4"
66003	3/16"
66006	5/16"
66010	7/16"
66015	7/16" Heavy Duty

HITCH PINS

Part #	Size (Dia. x Usable Length)
66100	1/2" x 4 1/4"
66105	5/8" x 6 1/4"
66110	3/4" x 4 1/4"
66120	7/8" x 6 1/4"
66125	1" x 6 1/4"
66130	1 1/8" x 6 1/4"



66010



66100

Hardware

Snapper pins are an excellent way to retain ramps and other attachments to your trailer. Yellow zinc plated for corrosion resistance.



66053

SNAPPER PINS			
Part #	Size	Usable Length	Usable Height
66045	3/8" x 3/4"	1 1/8"	1 1/2"
66050	1/4" x 2"	1 3/4"	1 1/2"
66053	5/16" x 2 3/4"	2 1/2"	1 5/8"
66056	3/8" x 1 5/8"	1 1/2"	1 1/2"
66060	3/8" x 2 1/2"	2 1/4"	1 1/2"
66063	1/4" x 2 3/4"	2 1/2"	1 3/4"
66066	1/4" x 3 1/4"	3"	1 1/2"
66070	1/4" x 3 3/4"	3 1/2"	1 1/2"

The S-hook provides a quick and easy way to connect chains. They are made of a high-alloy steel and have a zinc finish. Quick-links are ideal for connecting chains, cables, wires and ropes.



Q38

S38



S-HOOKS AND QUICK-LINK CONNECTORS				
Part #	Type	Diameter	Load Limit	Inside Length
S316	S-hook	3/8"	75 lbs.	1 11/16"
S14	S-hook	1/4"	200 lbs.	1 25/32"
S516	S-hook	5/16"	185 lbs.	2 1/4"
S38	S-hook	3/8"	270 lbs.	2 3/8"
Q316	Q-link	3/8"	750 lbs.	1 5/8"
Q14	Q-link	1/4"	1,250 lbs.	1 3/4"
Q516	Q-link	5/16"	1,900 lbs.	2 1/4"
Q38	Q-link	3/8"	2,650 lbs.	2 1/2"



B38

B50

B40



B601

B48

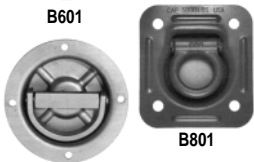

B901

B801



B701

B20

B23

We carry a full line of D-rings and lashing rings in various sizes. They are available for both rope-ties (light-duty) and chain-type ties (heavy-duty).

LASHING AND D-RINGS				
Part #	Ring Type	Capacity	Ring Diam.	Inner Diam.
B38	D-ring	11,781 lbs.	1/2"	2 1/2" x 2 3/8"
B40	D-ring	18,380 lbs.	5/8"	3" x 3"
B46	D-ring	26,500 lbs.	3/4"	3" x 3"
B48	D-ring	46,760 lbs.	1"	3" x 3"
B50	D-ring	46,760 lbs.	1"	4" x 3"
B20	Lashing ring	700 lbs.	1/4"	n/a
B23	Lashing ring	1,000 lbs.	1/4"	n/a
B601	Lashing ring	500 lbs.	1/4"	n/a
B701	Lashing ring	500 lbs.	1/4"	n/a
B801	Lashing ring	5,000 lbs.	5/16"	n/a
B901	Lashing ring/Rotating	5,000 lbs.	n/a	n/a

Hardware

Tie loops are used in conjunction with a rope or when a halter-type tie is needed. They are available in either bolt-on or weld-on versions and in metal or aluminum.

TIE LOOPS				
Part #	Description	Dimensions	Style	Application
TL12R	Metal	2" x 1/2"	Round	Weld-on
4229-1NT	Metal	2" x 1/2"	Round	Weld-on
TL38SQ	Metal	2 1/4" x 3/8"	Square	Weld-on
TL12RA	Aluminum	2" x 1/2"	Round	Bolt-on

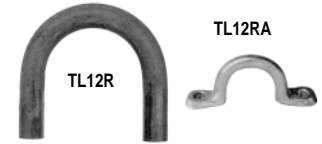

Weld-on stake pockets are for use on truck or flatbed trailers. These stake pockets will accept standard 2" x 4" stakes.

STAKE POCKETS	
Part #	Description
7403	3" tall, 1 1/8" x 3 1/2" inner diameter, 4GA
7404	3" tall, 1 1/8" x 3 1/2" inner diameter, 9GA

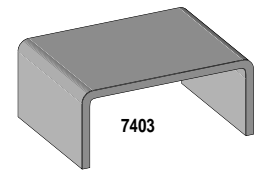

These universal tow hooks are made of drop forged steel. They have a maximum safe working load of 10,000 lbs. 5" long, 1/2" holes placed 1 3/8" between hole centers.

TOW HOOKS	
Part #	Description
B2799B	Black enamel
B2799C	Chrome plated

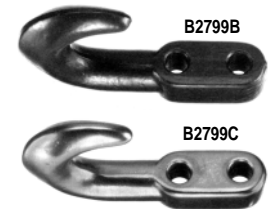

Folding steps are 4" wide and bolt on with two 5/16" bolts with hole centers spaced 3.89" apart.

FOLDING STEP	
Part #	Description
B2797P	Plain finish
B2797SS	Stainless steel
B2797Z	Zinc plated



Spring-loaded latches make for an easy release mechanism for light utility and boat trailers. It's the ideal release system for "tilt type" trailers.

TIPPER LATCH	
Part #	Description
3501-F	Tipper latch
3027-RE	Tipper latch reversed

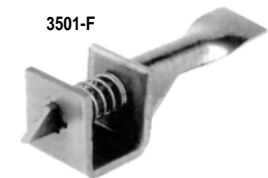

This rear door latch is the ideal latch system for stock trailers. The complete unit includes a steel bar, handle and catch. Use vinyl grips for an extra touch.

REAR DOOR LATCH	
Part #	Description
L312	3 piece rear door latch, complete

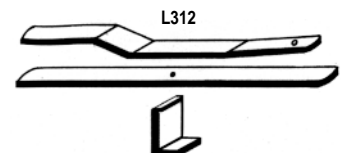

Hardware

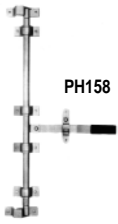

Note: Does not include the pipe.

These universal cam action door locks are designed to use a 3/4" pipe. The support plates offer easy installation.

UNIVERSAL CAM-DOOR LOCK

Part #	Description
PH158	Universal cam-door lock
B2158	Universal cam-door lock, Buyers

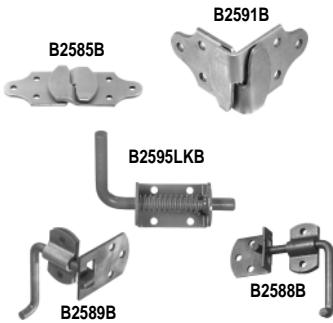

These latches and connectors make the job of building stake sides much easier. Zinc plated components also available by adding "Z" onto the end of the part number.

STAKE BODY COMPONENTS

Part #	Description
B2595LKB	Spring latch assembly and keeper, zinc plated
B2585B	Straight connector set, 1 left hand and 1 right hand pair
B2591B	Corner connector set, 1 left hand and 1 right hand pair
B2588B	Straight side latch set
B2589B	Corner latch set

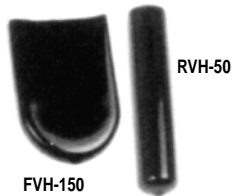

Our black grips are designed to fit over stock trailer door handles and latches. They simply slide over the end of the handle/latch. The ideal finishing touch.

VINYL HANDLE GRIPS

Part #	Description	Size
FVH-150	Flat grip	1 1/2" wide x 3" long x 1/4"
FVH-200	Flat grip	2" wide x 3" long x 1/4"
RVH-50	Round grip	3" long x 1/2" diameter
RVH-60	Round grip	3" long x 5/8" diameter
RVH-70	Round grip	3" long x 3/4" diameter

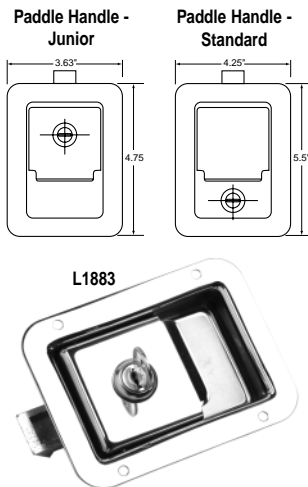

These latches feature a stainless-steel spring. They are available with or without locking cylinders and in both plain and stainless steel finishes.

FLUSH MOUNT LATCHES

Part #	Description	Finish	Locking	Pre-drilled	Mounting Hole
L1980	Latch	Plain	Yes	No	2 3/4" x 3 3/4"
N1980	Latch	Plain	No	No	2 3/4" x 3 3/4"
L1930	Latch	Plain	Yes	No	2 3/4" x 3 3/4"
L1883	Latch	Stainless	Yes	Yes	2 3/4" x 3 3/4"
L1833	Latch	Stainless	Yes	Yes	2 3/4" x 3 3/4"
L3980	Latch	Plain	Yes	No	3 3/8" x 4 1/2"
N3980	Latch	Plain	No	No	3 3/8" x 4 1/2"
CH510	Repl. key, #510				
CH545	Repl. key, #545				
CHKT	Repl. key and tumbler set				

Hardware

These cab locks mount to the trailer door. No mortising or blocking is required for installation. They are fitted with a carbon-tempered flat steel spring for dependable and smooth operation and are available in both left and right-hand models. They can be used with either "T" or "L" handles with 1/4" shaft. 3 3/8" X 2" lock dimensions.

CAB LOCKS	
Part #	Description
57LH	With thumb release, left hand
57RH	With thumb release, right hand
58LH	Without thumb release, left hand
58RH	Without thumb release, right hand

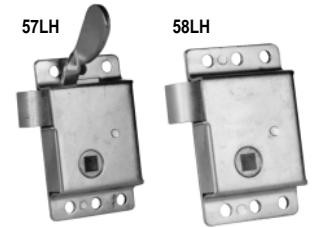

These precision, high quality handles have a 1/4" square by 2 1/2" shaft that allows various mounting and variations in door thickness. Handles have a cab-lock design and are available in locking and non-locking models.

HANDLES	
Part #	Description
6921	"L" style locking handle
6920	"T" style locking handle

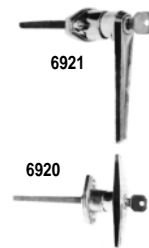

Made of stamped steel and zinc-plated hardware these door holders are designed for holding doors open against the side of a trailer. **Note:** DH100 is only a holder and must be used with a plunger.

DOOR HOLDER AND PLUNGERS			
Part #	Capacity	Overall Length	Plunger Length
DH100	Socket and rubber insert	n/a	n/a
DH158	Plunger end	1 5/8"	1 1/4"
DH218	Plunger end	2 1/8"	1 3/4"
DH258	Plunger end	2 5/8"	2 1/4"
DH318	Plunger end	3 1/8"	2 3/4"

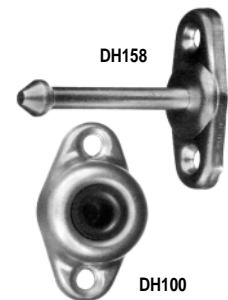

DOOR HOLDER	
Part #	Capacity
5601	Hook and keeper assembly
5601-SS	Hook and keeper assembly, stainless steel



These latches are zinc-plated with a heavy-duty "pull-down"-type catch. The draw-up tension allows for secure holding. Both have mounting holes.

SUITCASE-TYPE LATCH		
Part #	Description	Size
L207	With lock hole	3 1/16" x 1 1/32"
L208	Without lock hole	3 1/16" x 1 1/32"

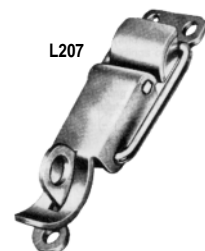

Hardware

The continuous hinge can be used for many applications in the horse and stock trailer industry. This hinge rotates 270° and is commonly referred to as a piano hinge.

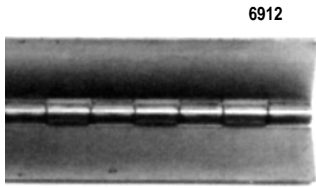

6912

CONTINUOUS HINGE				
Part #	Flat Width	Length	Pin Size	Hinge/Knuckle Size
6912	1½"	6'	¼"	½"
6913	2"	6'	⅜"	⅝"
6911	3½"	6'	¼"	1"
6910	2½"	6'	⅜"	⅝"

Hinge pin nipples are welded to the frame and door to custom-build your own heavy-duty door hinges.

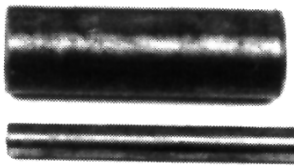

F-75225

HINGE PIN AND NIPPLE			
Part #	Diameter	Length	Description
F-75225	½" ID	2¼"	Hinge pin nipple
HP412	½" OD	4½"	Hinge pin
HP412Z	½" OD	4½"	Hinge pin with zerk
HP712Z	½" OD	7½"	Hinge pin with zerk

This roller and pin assembly is used for sliding doors and gates. The pin is 1/2" diameter and 2" long. The roller is 7/16" wide and has a 1/2" inner diameter.



PRA-1

ROLLER AND PIN ASSEMBLY	
Part #	Description
PRA-1	Roller and pin assembly

Our spare tire carriers are offered in two different styles and configurations. They are used to mount spare tires to boat, utility, horse and livestock trailers.

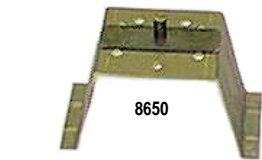

8650

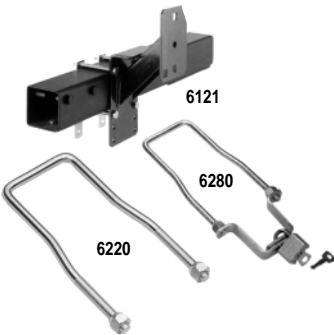

6121

6280

6220

SPARE TIRE CARRIER	
Part #	Description
6220	Spare tire carrier, fits 4 or 5 hole rims
6280	Spare tire carrier, fits 4 or 5 hole rims, with lock
6121	Spare tire bracket, fits 4 or 5 hole rims, fits 3" x 5" tongue, 14" maximum tire and wheel size
8650	Spare tire bracket, fits 6 or 8 hole rims

The continuous panel construction of the Tuff-Box underbody toolbox increases the durability of the box while creating a natural seal against water. The steel box is finished with black powder coat for exceptional corrosion resistance.

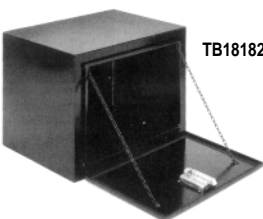

TB181824B

UNDERBODY TOOLBOXES		
Part #	Description	Material
TB181824A	18" X 18" X 24"	.100 Treadplate aluminum
TB181824B	18" X 18" X 24"	14 gauge steel sides and 12gauge steel door
TB181836A	18" X 18" X 36"	.100 Treadplate aluminum
TB181836B	18" X 18" X 36"	14 gauge steel sides and 12gauge steel door
TB181848A	18" X 18" X 48"	.100 Treadplate aluminum
TB181848B	18" X 18" X 48"	14 gauge steel sides and 12gauge steel door

Hardware

Universal mounting brackets for underbody tool boxes are constructed of heavy duty 2" C-channel A-36 steel and black powder-coated for corrosion resistance.

UNIVERSAL MOUNTING BRACKETS

Part #	Size	Weight
1701005	18" x 18"	16 lbs.

1701005



Trailer tongue toolboxes are designed to mount to the front of A-frame style trailers. These boxes offer an easy way to add secure storage to your trailer.

TRAILER TONGUE TOOLBOXES

Part #	Material	A	B	C	D
TBA342114B	Steel	34"	20.75"	14.25"	16"
TBA261422B	Steel	26"	14"	22.5"	12"
TBA483316B	Steel	48"	33"	16"	16"
TBA342114A	Aluminum	34"	20.75"	14.5"	15"
TBA493715A	Aluminum	49"	37"	15"	18.5"
TBA322020P	Polymer	32"	20"	20"	13"
TBA443120P	Polymer	44"	31"	20"	18"

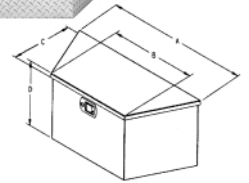

The EZ Jack was designed as an easy-to-use, safe and reliable device for changing tires on tandem axle trailers. Its unique rocker shape allows trailer operators to simply drive the trailer onto the EZ Jack to elevate the tire to change. No more hassling with awkward jacks or wooden blocks.

EZ JACK

Part #	Description
EZ JACK	Heavy duty, cast aluminum jack

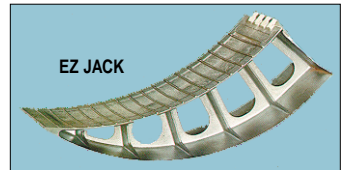

EZ JACK in use



Our painted, steel ramps make a great option for manufacturers. These high quality ramps are available in your choice of lengths. Sold in pairs.

RAMPS

Part #	Description
7119	12" x 48", pair
7120	12" x 60", pair
7118	15" x 48", pair

7119



RAMP ASSIST SPRING

Part #	Description
CSB0230	Ramp assist spring, 1 1/4" inner diameter, pair

CSB0230



Rubber bumpers can be used as cushions for handles, door stops or dock bumpers.

RUBBER BUMPERS

Part #	Outer Diameter	Height	Recessed Diameter	Mounting Hole
B-1	2 1/2"	1"	1 1/8" x 1/2"	3/8"

B-1

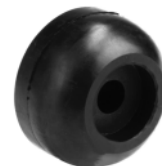

Hardware

D-shaped, pre-drilled rubber bumpers have become standard in all types of trailers; especially horse trailers. They prevent damage to the trailer and cargo. **NOTE:** Custom lengths available.

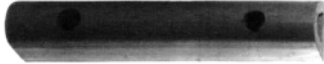

6254

RUBBER D-BUMPERS		
Part #	Size	Holes
6254	3" x 96" D-bumper	Holes on 11" centers, 5/16" diameter
6257	4" x 96" D-bumper	Holes on 11" centers, 5/8" diameter

FS275



FS225



FS150



These torx floor screws are 1/4" in diameter. They have type "F" flat heads and self-tapping points. They make an easy and cost-effective way to secure wood flooring to trailers. A 7/32" pilot hole is required.

TORX FLOOR SCREWS				
Part #	Part # by the box	Description	Length	Diameter
FS150	FS150-2000	Torx floor screw	1 1/2"	1/4"
FS225	FS225-1500	Torx floor screw	2 1/4"	1/4"
FS516	FS516-1000	Torx floor screw	2 1/2"	5/16"
FS275	FS275-100	Torx floor screw, self drilling	2 3/4"	1/4"



TBH1/4

TORX DRIVER AND DRILL BIT	
Part #	Description
6202	Torx bit driver
TBH1/4	Torx bit holder
6203	Drill bit, 7/32"

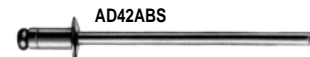

AD42ABS

POP RIVETS AND TOOL					
Part #	Rivet Diameter	Hole Size/ Drill # (Inch)	Grip Range	Quantity Per Box/Bag	5/8" Flange
AD42ABS	1/8"	3/64"/.129-.133	.032-.125	10,000	No
AD44ABS	1/8"	3/64"/.129-.133	.188-.250	10,000	No
AD45ABS	1/8"	3/64"/.129-.133	.251-.312	10,000	No
AD46ABS	1/8"	3/64"/.129-.133	.313-.375	10,000	No
AD48ABS	1/8"	3/64"/.129-.133	.376-.500	8,000	No
AD54ABS	5/32"	1/64"/.160-.164	.188-.250	7,000	No
AD56ABS	5/32"	1/64"/.160-.164	.251-.375	7,000	No
AD64ABS	3/16"	13/64"/.192-.196	.126-.250	5,000	No
AD64ABSLF	3/16"	13/64"/.192-.196	.126-.250	3,000	Yes
AD66ABS	3/16"	13/64"/.192-.196	.251-.375	4,500	No
AD66ABSLF	3/16"	13/64"/.192-.196	.251-.375	2,500	Yes
AD68ABS	3/16"	13/64"/.192-.196	.376-.500	4,000	No
AD610ABS	3/16"	13/64"/.192-.196	.501-.625	4,000	No
AD610ABSLF	3/16"	13/64"/.192-.196	.501-.625	2,000	Yes
AD612ABS	3/16"	13/64"/.192-.196	.626-.750	3,000	No
AD612ABSLF	3/16"	13/64"/.192-.196	.626-.750	2,000	Yes
PRT-1000	Pop rivet tool, four sizes of nose-pieces for rivets with diameters of 1/8", 3/32", 5/32", and 3/16"				

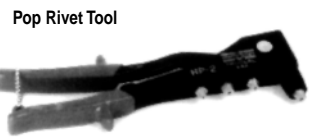

Pop Rivet Tool